

# UV LED CHIP SPECIFICATION

Model: NS375C-2SAA

Nitride Semiconductors Co., Ltd.

1. Name: UV LED Chip
2. Model: NS375C-2SAA
3. Material: GaN based material (This product complies with RoHS.)
4. Electrode: n-contact Au  
                   p-contact Au
5. Optical and Electrical Characteristics (Ta=25°C)

Item		Symbol	Condition	Min.	Standard	Max.	Unit
Forward voltage		$V_F$	$I_F=20\text{mA}$	3.2	3.6	4.2	V
Reverse current		$I_R$	$V_R=5\text{V}$	-	-	10.0	$\mu\text{A}$
Peak wavelength*1		$\lambda_p$	$I_F=20\text{mA}$	375	-	380	nm
Full width at half maximum		$\Delta\lambda$	$I_F=20\text{mA}$	-	12	-	nm
Optical output power*2	Rank 5	Po.	$I_F=20\text{mA}$	2.5	-	3.0	mW
	Rank 6			3.0	-	3.5	
	Rank 7			3.5	-	4.0	
	Rank 8			4.0	-	4.5	
	Rank 9			4.5	-	5.0	
	Rank 10			5.0	-	5.5	

\*1 Measurement error:  $\pm 2\text{nm}$

\*2 Optical output is the conversion value when the chip is mounted on TO-18 header. (Measurement error: 10%)

6. Storage temperature and period
  - (1) Storage temperature and humidity: 5~35°C, 45~85%
  - (2) Storage period: three months

7. Dimensions, design and cross-section diagram

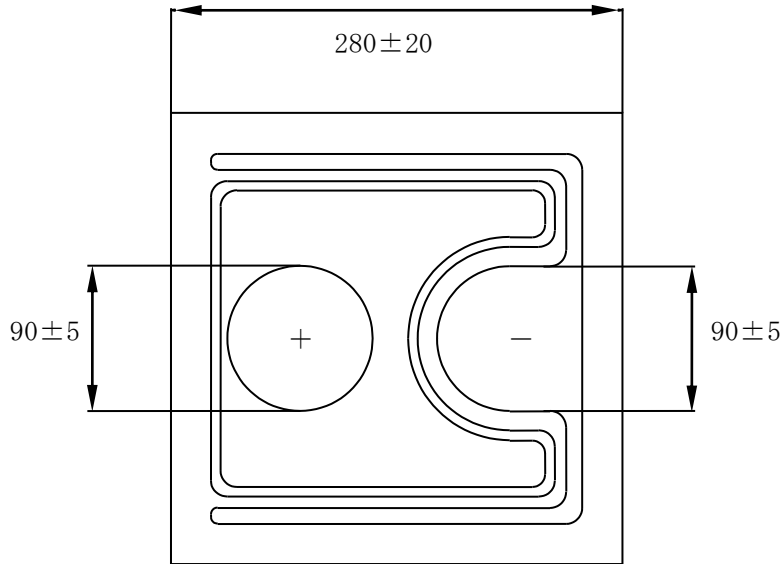

Dimensions and design

- \*3 Thickness:  $120\mu\text{m} \pm 20\mu\text{m}$
- \*4 Dimensions are in typical value
- \*5 Unit:  $\mu\text{m}$

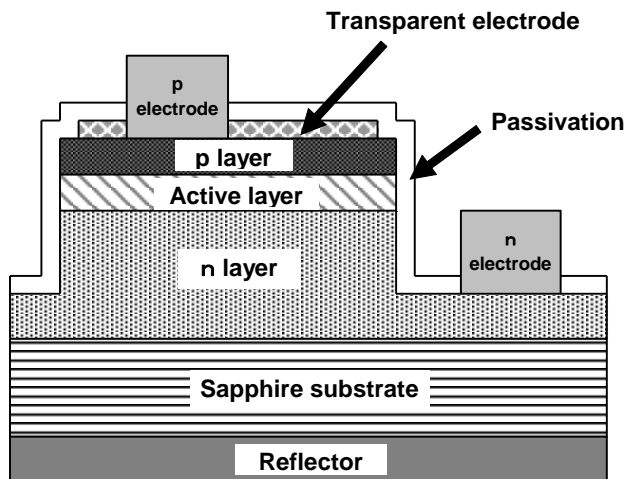

Cross-section diagram

## 8. Configuration

Chips are attached on an arranging sheet.

Arranging sheet: Tecni tape T4, TECNISCO

Sheet size: 200mm x 200mm

Adhesive side: the back of chips

Arranging pitch: 0.43mm

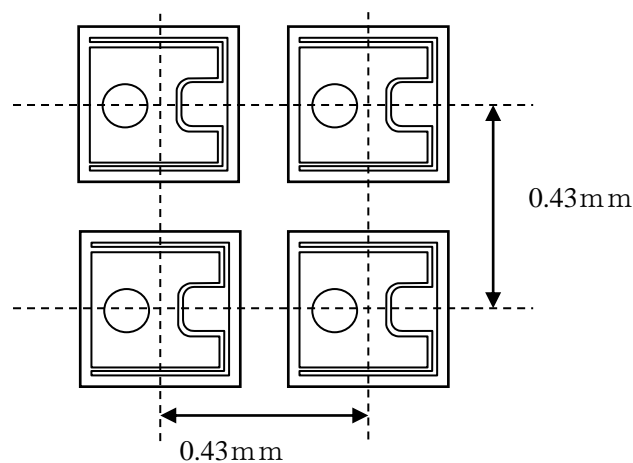

## 9. Inspection

- (1) All chips will be inspected on each item of the electrical and optical characteristics ( $V$ ,  $I_R$ ,  $P_o$ ,  $\lambda_p$ ,  $\Delta\lambda$ ) following the article 5.
- (2) Verification of quantity: Calculated quantity of chips on an arranging sheet without shortage.

## 10. Package and label.

- (1) Package: Sealed in an antistatic bag and a carton box.
- (2) Label: A label indicating model, lot no. and quantity attached.

## 11. Cautions

- (1) The LEDs emit very strong UV radiation. Do not look directly at the LEDs. UV radiation may harm your eyes. To prevent inadequate exposure of UV radiation, wear UV protective glasses.
- (2) The chips are very sensitive to static and surge. Take a full protection against static and surge.
- (3) Please handle with care when taking out the chips on sheet.

NS375C-2SAA  
210122-NS

- (4) Paste with resistance to UV light used for chip mounting is recommended.

## 12. Warranty

- (1) The warranty is valid for UV LED chips only complying with this specification described in the articles 5 to 10.
- (2) Perform an acceptance inspection on arrival of the goods. Return the defectives if any stipulating the disqualification and quantity.
- (3) The warranty period is for three months after the date when the chips are delivered to user. However any defect or malfunction caused by the following cases is not to be applied to the warranty even during the warranty period.
  - ① Loading mechanical stress on the chips except the normal bonding.
  - ② Neglectful handling or improper use.
  - ③ Caused by force majeure and natural disasters such as fire, earthquake, flood and lighting.
  - ④ Unwarranted repair or modification.
- (4) Embedding the chips on to the application and the verification of life and other qualities in practical use shall be executed by user.
- (5) This product described in this specification is intended to be used for ordinary electronic equipment (such as office equipment, communications equipment, measurement instruments and household appliances).

Do not use for special applications such as aviation, spacecraft, heating equipment and life-sustaining equipment which require exceptionally high reliability and safety, as their failure or malfunction may threaten human safety.

It is to be understood that the seller shall not be held responsible for any damage incurred as a result of using this product for a purpose which is not a standard use for which the seller intended, unless the seller agrees to the non-standard use in writing.

- (6) Users are required to use within specifications when designing. It is to be understood that the seller shall not be held responsible for any defect or malfunction after using out of warranty scope.

## 13. Others

- (1) Technical information described in this specification shows only product's characteristics and that does not mean the protection of intellectual property right for seller and a third party or grant of license.
- (2) The appearance and specifications are subject to change for improvement without prior notice.

Optical and electrical characteristics

■ Forward voltage vs. Forward current

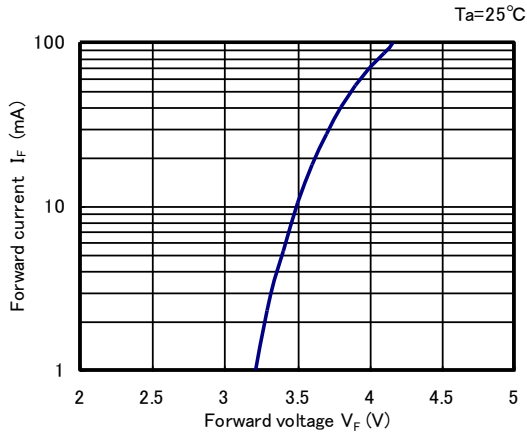

■ Forward current vs. Relative output power

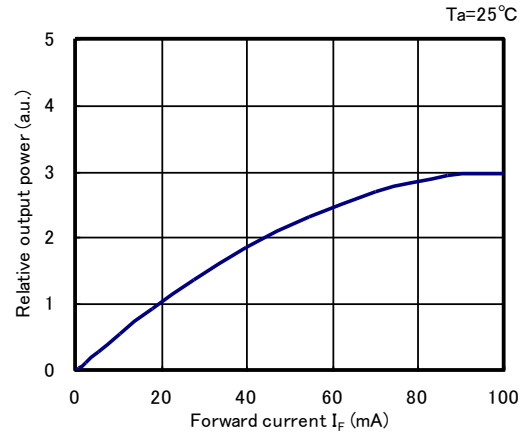

■ Ambient temperature vs. Relative output power

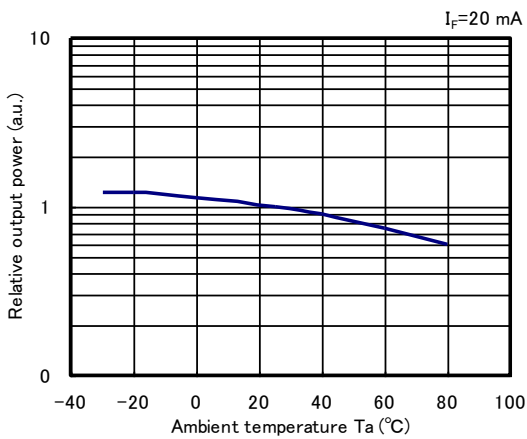

■ Ambient temperature vs. Forward voltage

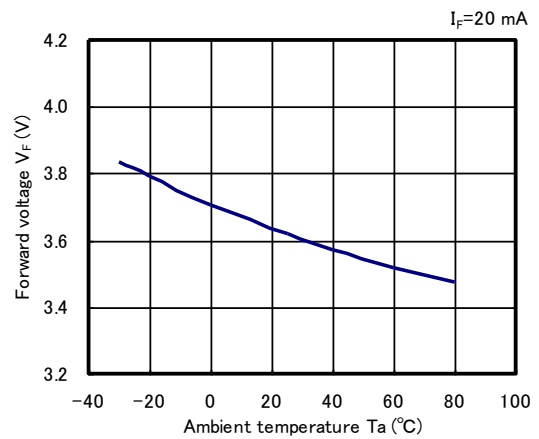

■ Spectrum

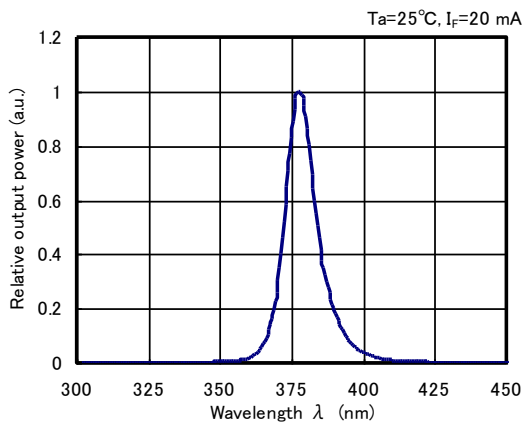

Optical and electrical characteristics depend on packaging method. The above data is for resin mold packaged LED.